

KOMERČNÍ VENTILACE

LINEO ES

ROZMĚRY

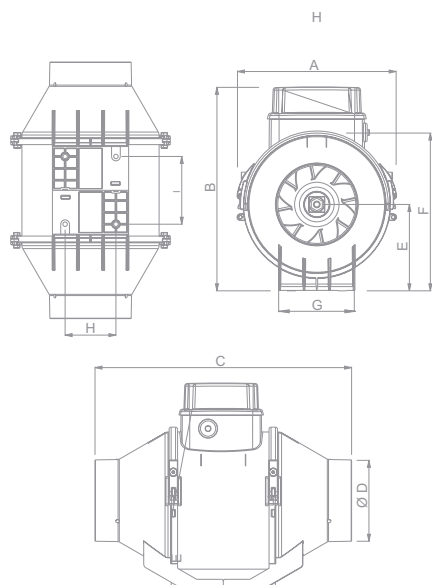

Model	Code	A	B	C	Ø D	E	F	G	H	I	Kg
LINEO 100 Q ES	17036	156	205	231	96	82	152	95	51.5	47.5	1.5
LINEO 100 ES	17031	188.5	240	303	96	101.5	189	90	60	80	1.9
LINEO 125 ES	17032	188.5	240	258	122	101.5	189	90	60	80	1.8
LINEO 150 ES	17033	214.5	265	294	146	112.5	212	110	60	80	2.2
LINEO 160 ES	17034	214.5	265	272.5	156	112.5	212	110	60	80	2.1
LINEO 200 ES	17037	234.5	290	300	196	125.5	235	140	94	100	2.5
LINEO 250 ES	17038	300	350	385	247	152.5	292	176.5	140	145	5.3

Rozměry v (mm)

TECHNICKÁ DATA

Models	Code	Příkon W		Proud A		Průtok (m ³ /h)		Průtok (l/s)		Tlak (Pa)		Tlak (mmH ₂ O)		Otáčky		Úroveň hluku 3 m dB(A)*	
		min speed	max speed	min speed	max speed	min speed	max speed	min speed	max speed	min speed	max speed	min speed	max speed	min speed	max speed	min speed	max speed
LINEO 100 Q ES	17036	4.5	7	0.05	0.08	90	145	25	40	35	78	3.6	8	1420	2120	21.0	33.3
		7	12	0.07	0.12	155	210	43	58	88	147	9	15	2125	2850	28.9	40.0
		10	16.5	0.10	0.16	170	230	47	64	108	177	11	18	2560	3300	33.5	44.5
LINEO 100 ES	17031	5.5	8	0.06	0.09	140	185	39	51	69	118	7	12	1320	1650	25.3	31.4
		8	12	0.09	0.12	180	255	50	71	118	225	12	23	1620	2000	31.4	36.4
		11	17	0.11	0.17	220	270	61	75	167	255	17	26	1920	2330	35.7	40.8
LINEO 125 ES	17032	6.5	10.5	0.07	0.11	190	270	53	75	88	157	9	16	1285	1660	28.9	35.1
		10	17	0.10	0.17	250	365	69	101	147	284	15	29	1600	2040	34.8	40.3
		13.5	24	0.13	0.22	300	380	83	105	196	324	20	33	1870	2370	39.3	44.4
LINEO 150 ES	17033	10	22	0.10	0.20	325	440	90	122	147	275	15	28	1340	1875	35.0	44.1
		15	35	0.15	0.31	385	550	107	153	216	422	22	43	1630	2230	41.6	47.1
		22	52	0.20	0.44	465	620	129	172	304	520	31	53	1870	2560	46.0	53.2
LINEO 160 ES	17034	10	23	0.10	0.21	325	450	90	125	147	275	15	28	1300	1900	33.8	44.6
		15	38	0.15	0.33	385	570	107	158	216	422	22	43	1560	2290	39.2	47.7
		22	55	0.20	0.45	465	630	129	175	304	520	31	53	1830	2620	45.7	54.1
LINEO 200 ES	17037	22	34	0.21	0.32	620	760	172	211	127	186	13	19	1990	2330	39.4	44.3
		36	57	0.33	0.50	750	1000	208	278	186	265	19	27	2400	2820	44.8	46.2
		53	74	0.47	0.63	870	1080	242	300	245	363	25	37	2750	3120	45.3	47.5
LINEO 250 ES	17038	27	59	0.26	0.54	650	850	180	236	186	333	19	34	1720	2280	43.0	50.9
		45	95	0.42	0.83	800	1150	222	319	284	500	29	51	2100	2750	47.4	55.0
		65	124	0.59	1.06	920	1250	255	347	363	637	37	65	2400	3010	50.4	57.3

Hodnoty v tabulce jsou pro 3 úrovně výkonu: minimální nastavení, nominální a maximální nastavení.

*Volné pole, měřeno u nasávání.

Elektrické napětí: 220-240V-50Hz.

KOMERČNÍ VENTILACE

LINEO ES

VÝKONOVÉ KŘIVKY

LINEO 100 Q ES
code 17036

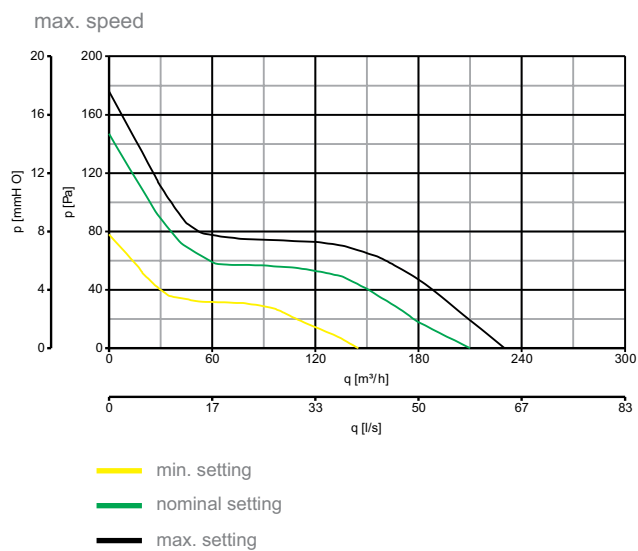
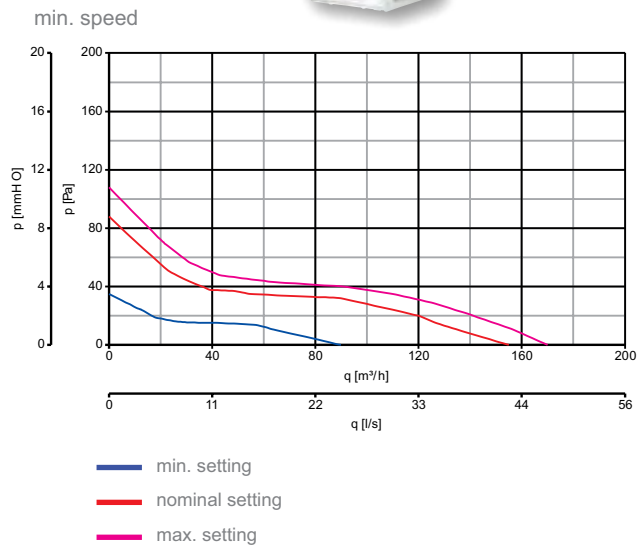

LINEO 100 ES
code 17031

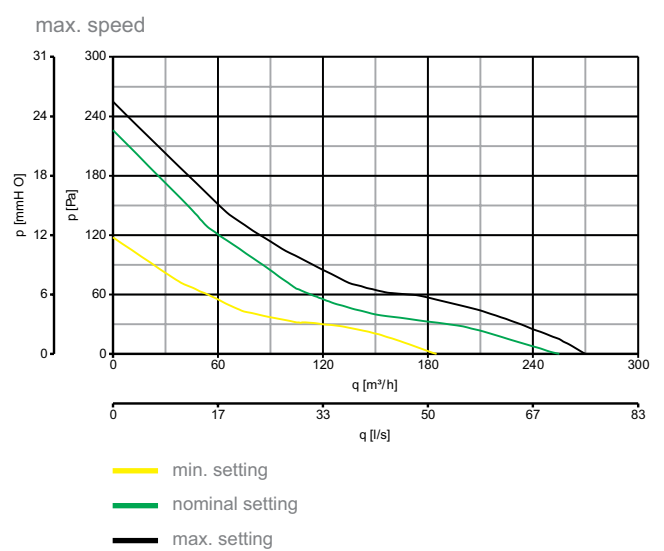
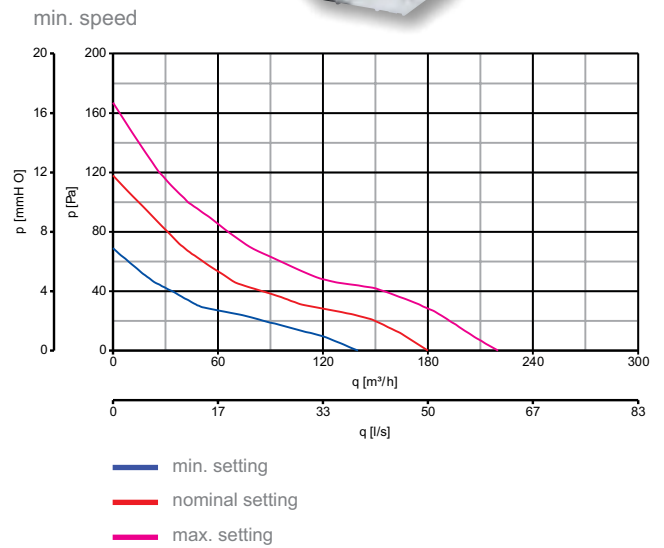

p = statický tlak

LINEO ES

PERFORMANCE CURVES

LINEO 125 ES
code 17032



min. speed

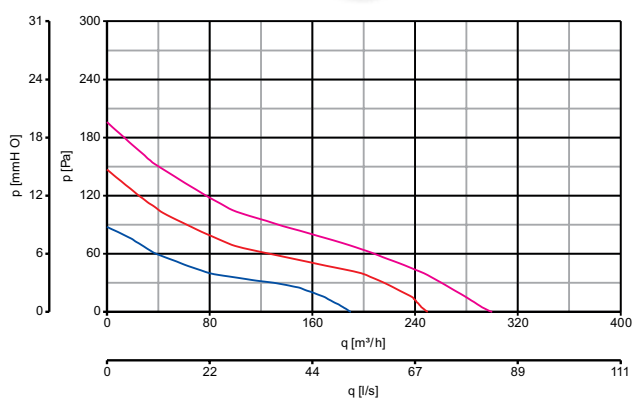

- min. setting
- nominal setting
- max. setting

max. speed

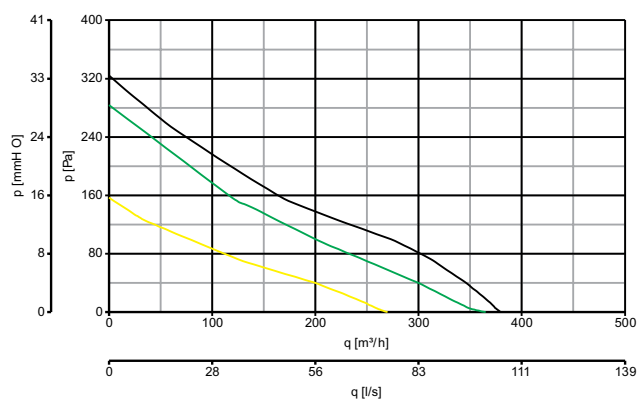

- min. setting
- nominal setting
- max. setting

LINEO 150 ES
code 17033



min. speed

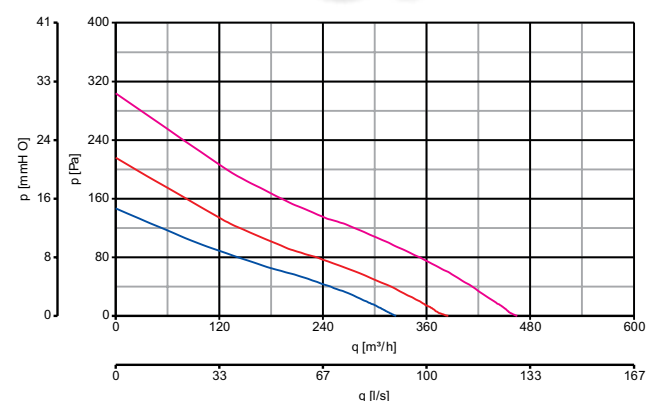

- min. setting
- nominal setting
- max. setting

max. speed

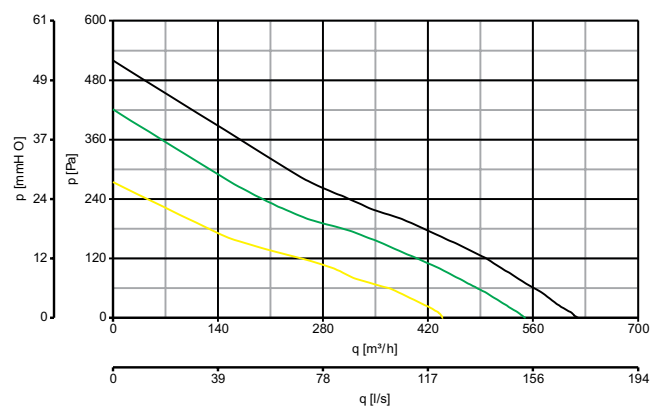

- min. setting
- nominal setting
- max. setting

p = statický tlak

LINEO ES

PERFORMANCE CURVES

LINEO 160 ES
code 17034



min. speed

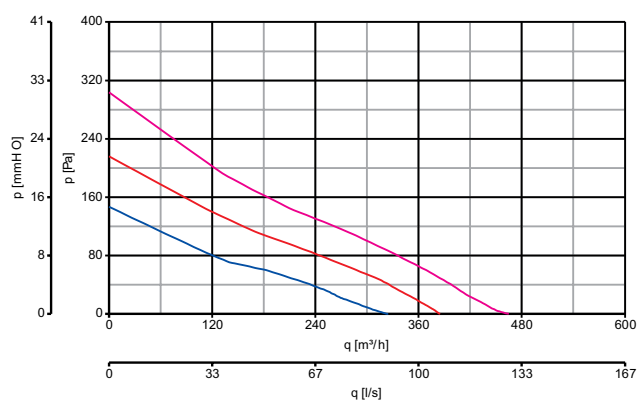

- min. setting
- nominal setting
- max. setting

max. speed

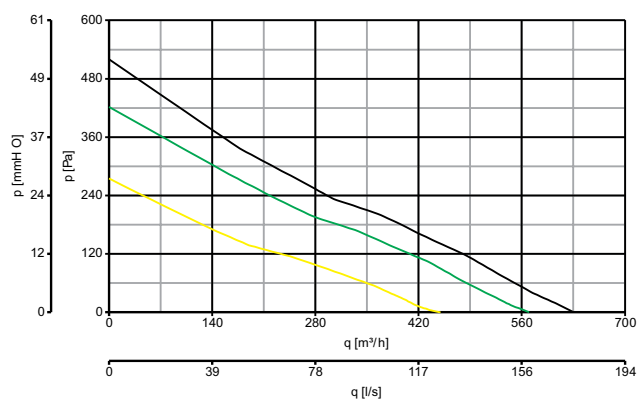

- min. setting
- nominal setting
- max. setting

LINEO 200 ES
code 17037



min. speed

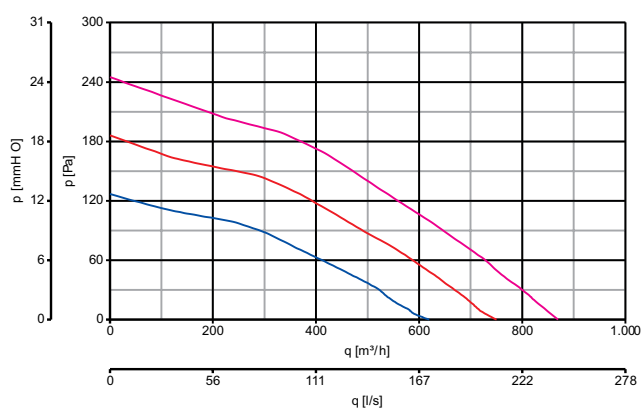

- min. setting
- nominal setting
- max. setting

max. speed

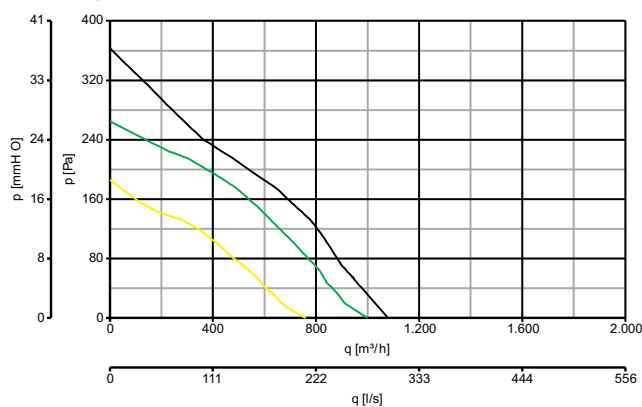

- min. setting
- nominal setting
- max. setting

p = statický tlak

LINEO ES

PERFORMANCE CURVES

LINEO 250 ES
code 17038



min. speed

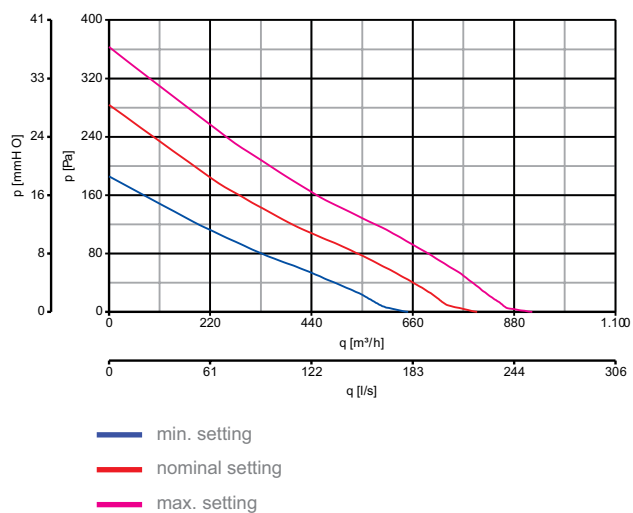

max. speed

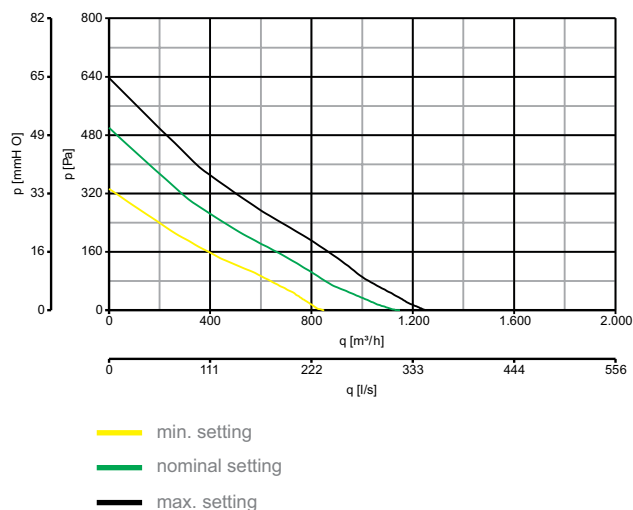

p = statický tlak